

**BASE SINGOLA CETOP 5 CON UTILIZZI A-B LAT. P-T POST.
SUB-PLATE CETOP 5 WITH A-B PORTS ON SIDE P-T BACK**

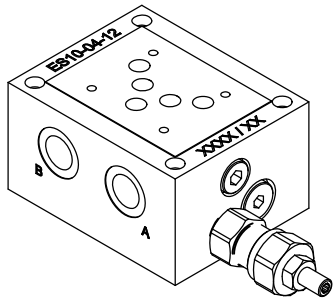

Schema idraulico
Hydraulic diagram

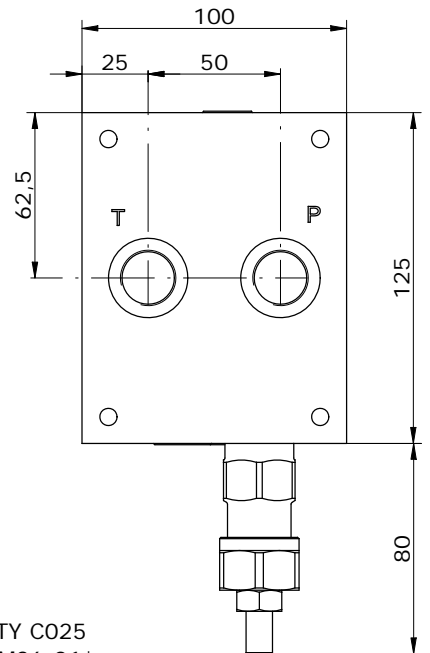
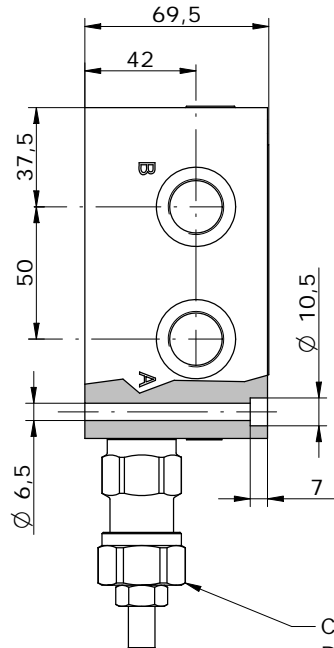
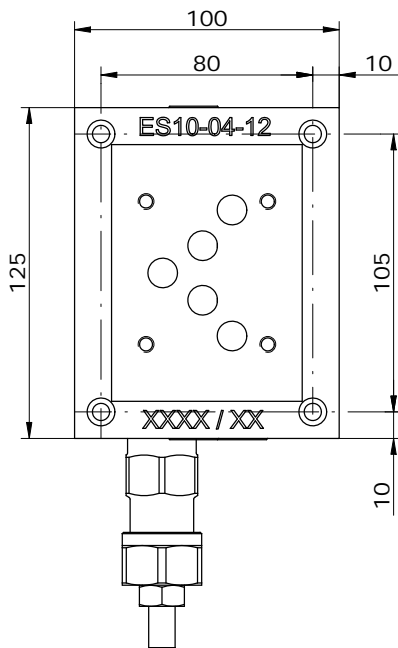
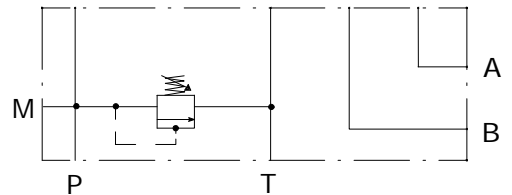

CAVITY C025
DRV-M26-01*

**TIPI DI REGOLAZIONE
REGULATION TYPE**

	H VITE CON CHIAVE ESAGONALE (standard) HEXAGONAL HEAD SCREW
	K POMOLO KNOB
	C FISSA CON CAPPUCCIO COVER CAP
	I INVIOLEBBILE NON ADJUSTABLE

**OPTIONAL
FITTING FOR GAUGE AND
PRESSURE SWITCH**

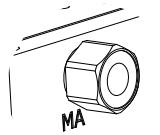

FG14

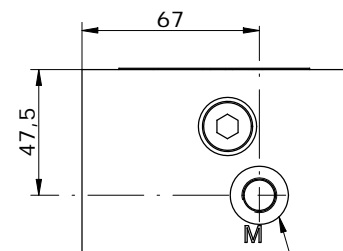

BSP 1/4G

E_ 10 - 04 - - - - -

S = STEEL
A = ALUMINUM

12 = BSP 1/2G
34 = BSP 3/4G

0 = WITHOUT RELIEF VALVE
1 = WITH RELIEF VALVE
2 = RELIEF VALVE READY

OMETTERE / OMIT
H = HEXAGONAL HEAD SCREW
K = KNOB
C = COVER CAP
I = NOT ADJUSTABLE

0 = WITHOUT RELIEF VALVE
1 = 5-55 BAR
2 = 25-110 BAR
3 = 75-250 BAR

*see **CARTDRIGE VALVES** catalog